

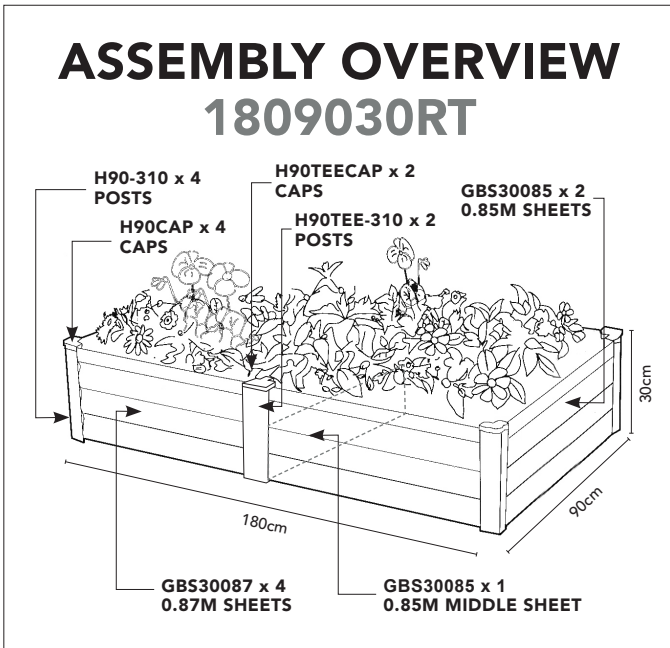



Farm fresh food at home

# T-Post Raised Garden Bed

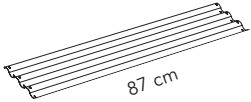

## PACKING LIST:

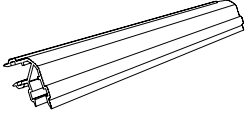
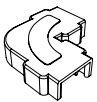
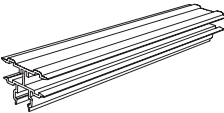
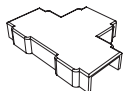
SHEETING			
PART NUMBER		QTY	CHECK
	GBS30087	4	
	GBS30085	3	
POSTS & CAPS			
	H90-310	4	
	H90CAP	4	
	H90TEE-310	2	
	H90TEECAP	2	

**Important:** It is advised that you install your garden bed on a flat/even surface to avoid leakages and maintain an even weight distribution.

Incorrect installation will void the warranty.

## ! FIRST STEPS

Using safety gloves, unpack your carton. Check off the parts using the packing list. When assembling, most parts should slide together with minimal effort. Use a rubber mallet to gently tap components into position. Any questions? Call us on 1800 029 701.

## 1 SLIDE SHEETS INTO POSTS

Organic Garden Co garden beds use the SNAPTITE Assembly System. Ensure that the lugs in the steel sheet click into the posts correctly, see below diagram.

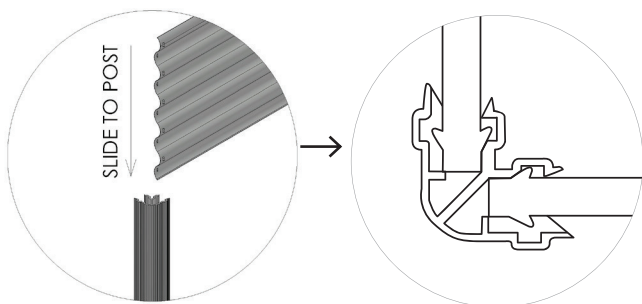

## 2 SAFETY CAPS

Clip on the safety caps to each post. Use a mallet to tap into place if necessary.

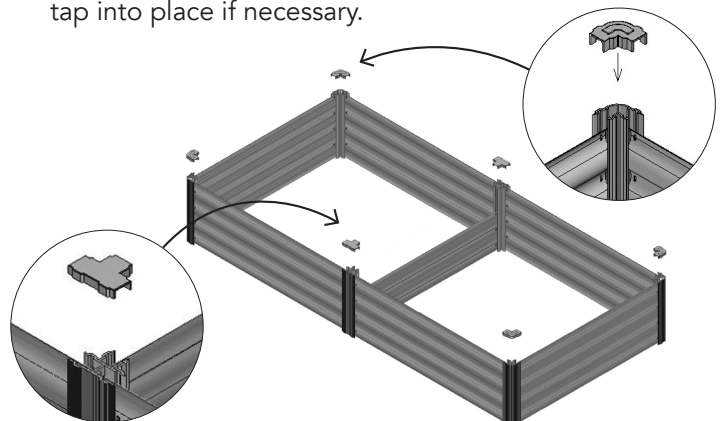



Farm fresh food at home

# Thank you for choosing The Organic Garden Co for your garden.

## Warranty

Raised Garden Beds are made using high quality Australian made steel, and rigid PVC components. We are pleased to advise we warrant that the steel panels and PVC posts will not split, bend, burst or fail, and the post to steel panel connections will retain their original structural integrity, for five years from date of purchase.

This warranty covers ORGANIC GARDEN CO. RAISED GARDEN BEDS used for normal domestic use and installed in accordance with the installation instructions. This warranty does not cover ORGANIC GARDEN CO. products installed in severe coastal, industrial or other highly corrosive environment. The warranty applies to the exclusion of all other representations, guarantees or warranties express or implied, our goods come with guarantees that cannot be excluded under the Australian consumer law and is not transferable

You are entitled to a replacement or refund for a major failure and for compensation for any other foreseeable loss of damage. You are also entitled to have the goods repaired or replaced if the goods fail to be of an acceptable quality and the failure does not amount to a major failure. For further information go to <http://consumerlaw.gov.au>

Please retain a proof of purchase (sales docket or invoice) or register your warranty within 30 days of purchase here: <https://www.organicgardenco.com.au/warranty>

In the unlikely event a warranty claim is made, it must be supported by photographic evidence and details of the defect, including component part numbers, together with proof of purchase documentation (or on-line registration of purchase) and forwarded to the address below. Upon receipt of the warranty claim, the Customer Service Manager will contact you within three business days to advise you of the assessment outcome of the claim, which may include expenses incurred in making the claim.

## Contact Us!

Available 7 days a week 8AM - 5PM AEST



[customerservice@organicgardenco.com.au](mailto:customerservice@organicgardenco.com.au)



1300 109 562