



**ABSCO
SHEDS**
So Tough. Too Easy.

**SHEDS &
OUTDOOR
STRUCTURES**
www.abscosheds.com.au

GARDEN SHEDS

BIKE SHEDS

ROLLER DOOR SHEDS

CHICKEN COOPS

ACCESSORIES



ASSEMBLY APP

AVAILABLE ON  + 

CONTENTS

04 SPACE SAVER STORAGE

06 PREMIER GARDEN SHED

08 REGENT GARDEN SHED

10 BASIC SHED / POOL PUMP COVER / BIKE SHEDS

11 EZI STORAGE

12 CHICKEN COOPS

14 HIGHLANDER SHED

15 UTILITY SHED

16 WORKSHOP SHED

17 FORTRESS SHED

18 BUSHRANGER SHED

19 ACCESSORIES

20 MATRIX TABLE

FEATURES & BENEFITS



ASSEMBLY APP AVAILABLE ON  + 

We highly recommend downloading the Absco Sheds Assembly App to assist with your build. Scan to download ►

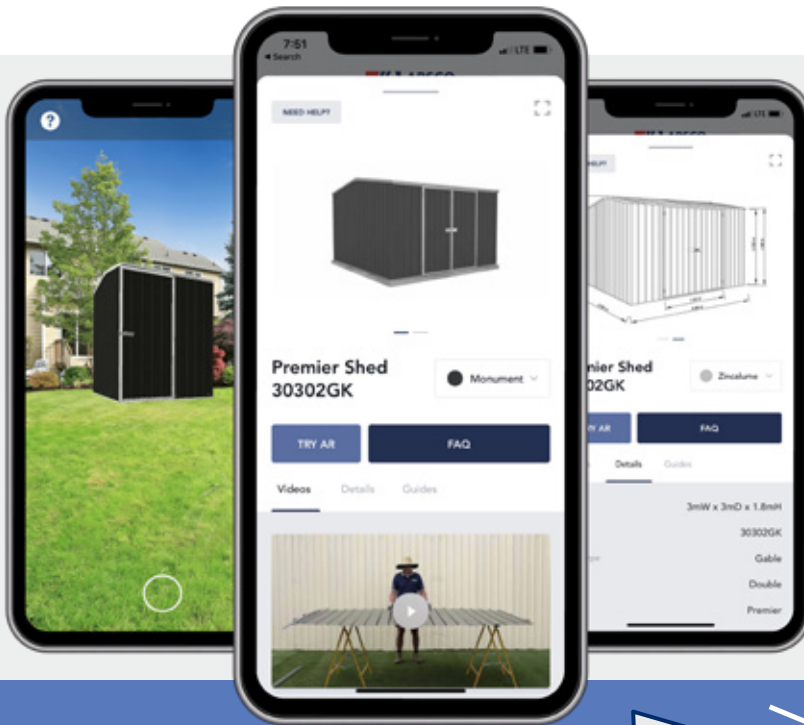

- ✓ In-depth Assembly Videos
- ✓ Parts Checklists
- ✓ FAQ
- ✓ 7 Day Customer Service
- ✓ Council Forms
- ✓ Instruction Manuals
- ✓ Augmented Reality

Assembly app available in:
French, Spanish, German and Dutch

SNAP TITE
World's Easiest Assembly System
UNIQUE PATENTED SYSTEM

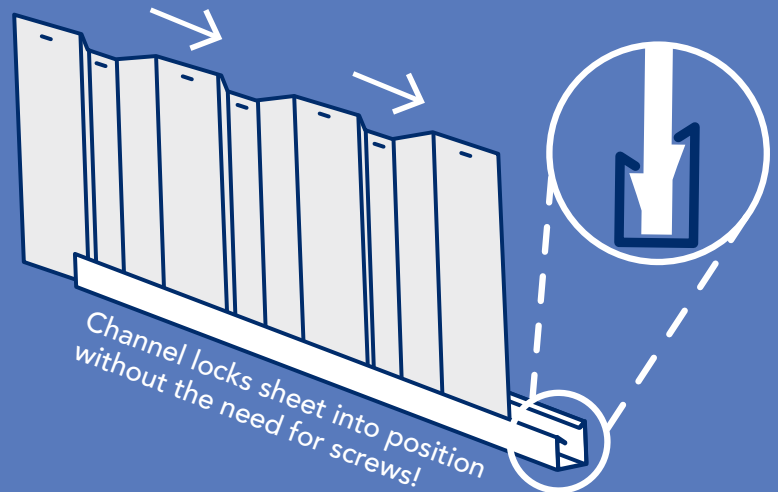

AUSTRALIAN
MADE



LIFETIME
WARRANTY



SNAPTITE
SYSTEM



FAST
ASSEMBLY



WIND
RATED



ASSEMBLY
APP



7 DAY
SUPPORT



STRONG
STEEL



PRE DRILLED
HOLES



LABELLED
PARTS



MAINTENANCE
FREE



ROLLED SAFETY
EDGES

SPACE SAVER STORAGE



MAINTENANCE
FREE



PRE DRILLED
HOLES



SNAPTITE
SYSTEM



The ultimate storage for those areas where space is limited. Fits under eaves and is large enough to store tools, sporting equipment and more. Ideal for storage in garages and carports in unit complexes.

15081SK shown in Zinalume®

PRODUCT

SPECIFICATIONS

DIMENSIONS



MODEL 15081SK

- » 1.52mW x 0.78mD x 1.95mH
- » Shown in Zinalume®
- » Skillion Roof, Single Door
- » Wind rated N2

20' FCL: 156 40' FCL: 390

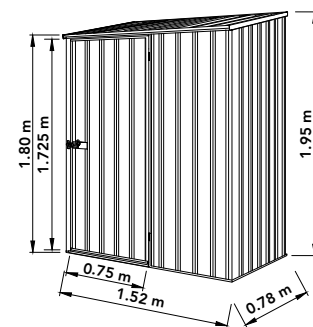

MODEL 15151SK

- » 1.52mW x 1.52mD x 2.08mH
- » Shown in Pale Eucalypt®
- » Skillion Roof, Single Door
- » Wind rated N2

20' FCL: 156 40' FCL: 390

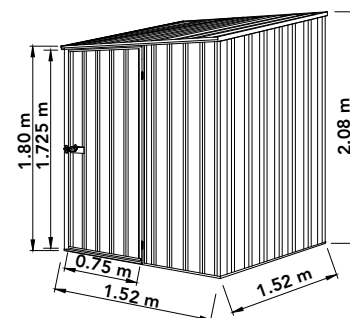

MODEL 23081SK

- » 2.26mW x 0.78mD x 1.95mH
- » Shown in Woodland Grey®
- » Skillion Roof, Single Door

20' FCL: 156 40' FCL: 390

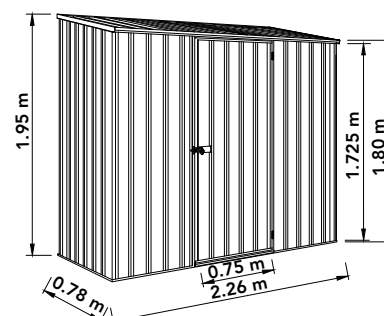



MODEL 23151SK

- » 2.26mW x 1.52mD x 2.08mH
- » Shown in Classic Cream™
- » Skillion Roof, Single Door
- » Wind rated N2

20' FCL: 156

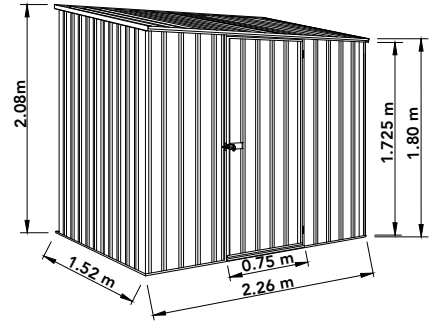

MODEL 30082SK

- » 3.00mW x 0.78mD x 1.95mH
- » Shown in Pale Eucalypt®
- » Skillion Roof
- » Hinged Double Doors

20' FCL: 156

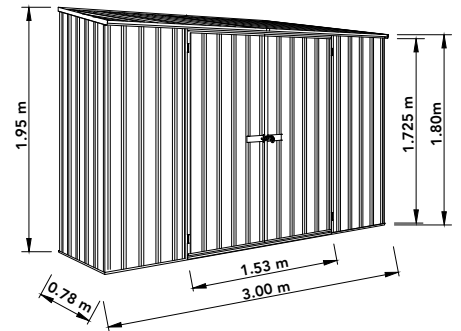

MODEL 30151SK

- » 3.00mW x 1.52mD x 2.08mH
- » Shown in Monument®
- » Skillion Roof, Single Door
- » Wind rated N2

20' FCL: 156

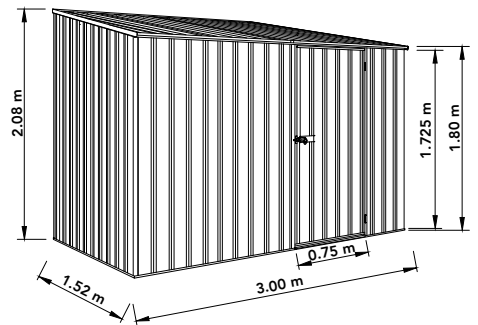

MODEL 30152SK

- » 3.00mW x 1.52mD x 2.08mH
- » Shown in Woodland Grey®
- » Skillion Roof, Double Door
- » Wind rated N2

20' FCL: 156

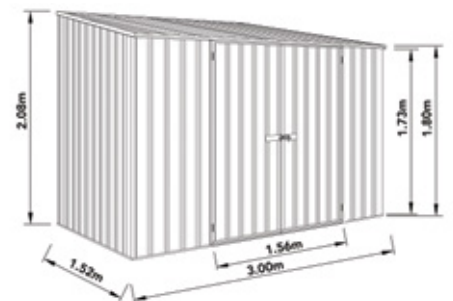

SPACE SAVER COLOUR OPTIONS:

Zincalume® (ZA)	Classic Cream™ (CC)	Pale Eucalypt® (PE)	Woodland Grey® (WG)	Monument® (MN)
--------------------	------------------------	------------------------	------------------------	-------------------



See specifications for wind ratings. CYCKRSK Cyclone kit available for these models. Excludes models 15081SK, 23081SK, and 30082SK.

PREMIER GARDEN SHED



WIND
RATED



LIFETIME
WARRANTY



ROLLED SAFETY
EDGES

FCL
156



30302GK Shown in Classic Cream™

Designed for maximum strength and manufactured from low maintenance ribbed steel sheeting for added security. Comes with gable roof and one or two door configurations. For number of doors and dimensions see model diagrams below.

PRODUCT

SPECIFICATIONS

DIMENSIONS



MODEL 15151GK

- » 1.52mW x 1.52mD x 1.95mH
- » Shown in Zinalume®
- » Gable Roof, Single Door
- » Wind Rated N2

20' FCL: 156 40' FCL: 390

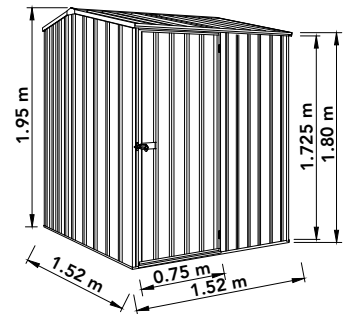

MODEL 23151GK

- » 2.26mW x 1.52mD x 1.95mH
- » Shown in Classic Cream™
- » Gable Roof, Single Door
- » Wind Rated N2

20' FCL: 156 40' FCL: 390

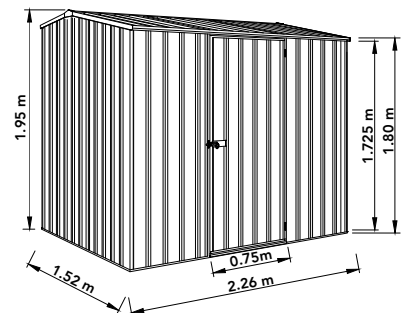



MODEL 23231GK

- » 2.26mW x 2.26mD x 2.00mH
- » Shown in Monument®
- » Gable Roof, Single Door
- » Wind Rated N2

20' FCL: 156

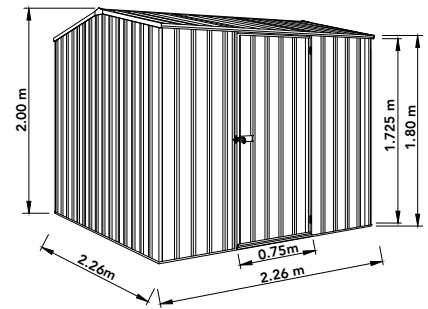

MODEL 30152GK

- » 3.00mW x 1.52mD x 1.95mH
- » Shown in Pale Eucalypt®
- » Gable Roof, Double Door
- » Wind Rated N2

20' FCL: 156

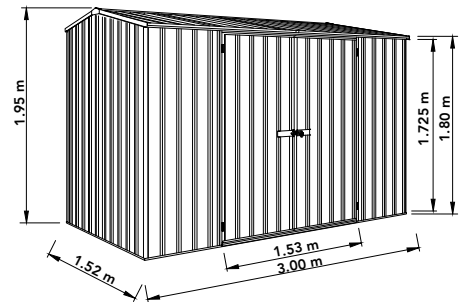

MODEL 30232GK

- » 3.00mW x 2.26mD x 2.00mH
- » Shown in Classic Cream™
- » Gable Roof, Double Door
- » Wind Rated N2

20' FCL: 156

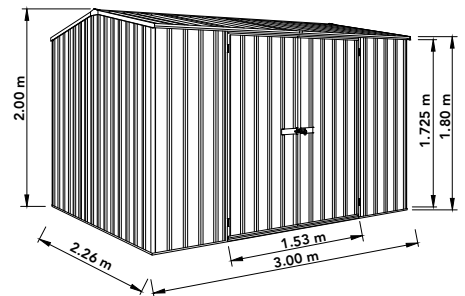

MODEL 30302GK

- » 3.00mW x 3.00mD x 2.06mH
- » Shown in Woodland Grey®
- » Gable Roof, Double Door
- » Wind Rated N2

20' FCL: 156

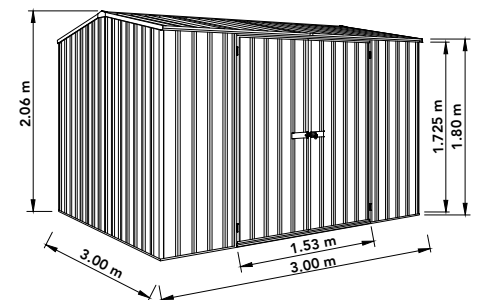

PREMIER COLOUR OPTIONS:

Zincalume® (ZA)	Classic Cream™ (CC)	Pale Eucalypt® (PE)	Woodland Grey® (WG)	Monument® (MN)
--------------------	------------------------	------------------------	------------------------	-------------------



Premier models are wind rated N2. CYCGK Cyclone kits available for these models. CYC15 available for 15151GK.

REGENT GARDEN SHED



ASSEMBLY APP



FAST ASSEMBLY



LABELLED PARTS



30142RK Shown in Woodland Grey®

Manufactured from low maintenance ribbed steel sheeting. Doors open at the gable end and the roof has a slight overhang to add to the overall appearance. Doors are hinged and braced for strength and rigidity.

PRODUCT

SPECIFICATIONS

DIMENSIONS



MODEL 23141RK

- » 2.26mW x 1.44mD x 2.00mH
- » Shown in Pale Eucalypt®
- » Gable Roof, Single Door
- » Wind Rated N2

20' FCL: 156

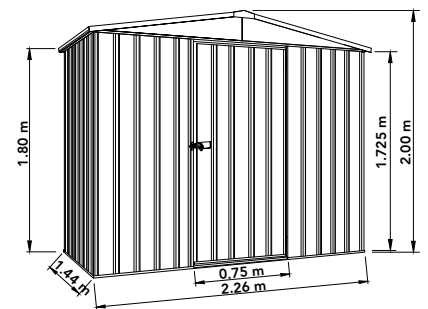

MODEL 23221RK

- » 2.26mW x 2.18mD x 2.00mH
- » Shown in Woodland Grey®
- » Gable Roof, Single Door
- » Wind Rated N2

20' FCL: 156

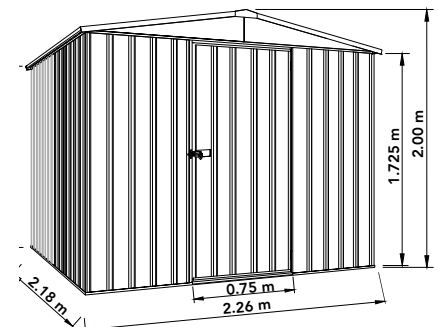



MODEL 30142RK

- » 3.00mW x 1.44mD x 2.06mH
- » Shown in Woodland Grey®
- » Gable Roof, Double Door
- » Wind Rated N2

20' FCL: 156

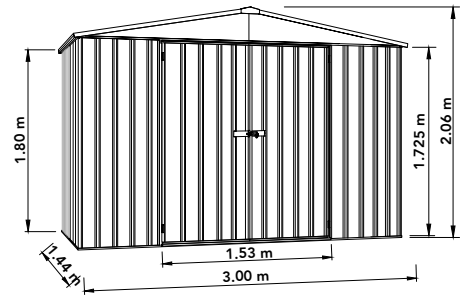

MODEL 30222RK

- » 3.00mW x 2.18mD x 2.06mH
- » Shown in Classic Cream™
- » Gable Roof, Double Door
- » Wind Rated N2

20' FCL: 156

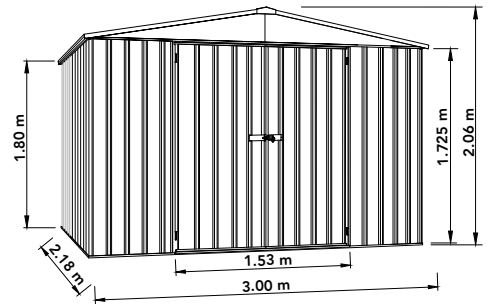

MODEL 30292RK

- » 3.00mW x 2.92mD x 2.06mH
- » Shown in Pale Eucalypt®
- » Gable Roof, Double Door
- » Wind Rated N2

20' FCL: 156

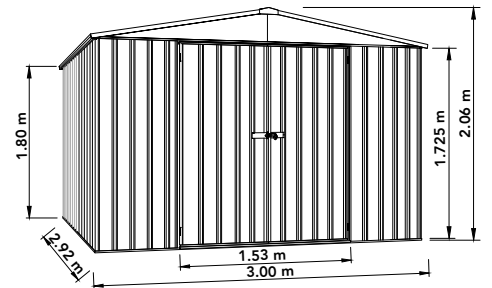

MODEL 30372RK

- » 3.00mW x 3.66mD x 2.06mH
- » Shown in Woodland Grey®
- » Gable Roof, Double Door
- » Wind Rated N2

20' FCL: 156

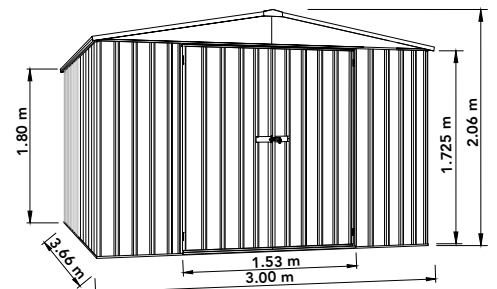

REGENT COLOUR OPTIONS:

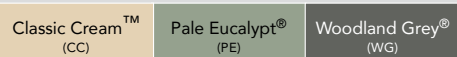

Regent models are wind rated N2. CYCRK Cyclone kits available for these models. CYC15 available for 15141RK.

BASIC SHED / POOL PUMP COVER / BIKE SHED

PRODUCT

SPECIFICATIONS

DIMENSIONS



BASIC SHED 15231FK

- » 1.52mW x 2.26mD x 1.80mH
- » Shown in Zincalume®
- » Not available in Pale Eucalypt®
- » Flat Roof, Single Door
- » Wind Rated N2

20' FCL: 156

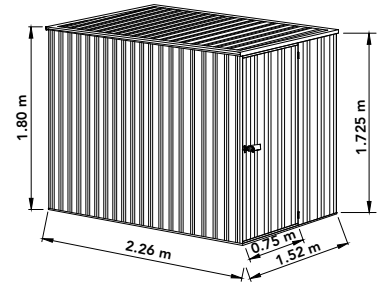

BASIC SHED 15301FK

- » 1.52mW x 3.00mD x 1.80mH
- » Shown in Monument®
- » Not available in Pale Eucalypt®
- » Flat Roof, Single Door
- » Wind Rated N2

20' FCL: 156

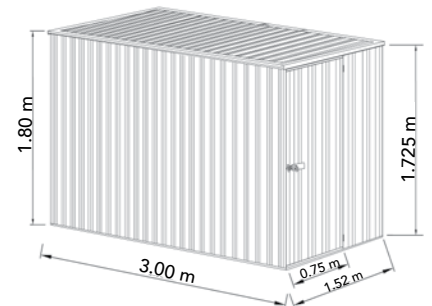

POOL PUMP COVER PPCK

- » 1.52mW x 1.52mD x 1.49mH
- » Shown in Woodland Grey®
- » Available in all colours
- » Hinged Skillion Roof
- » Front access door

20' FCL: 156

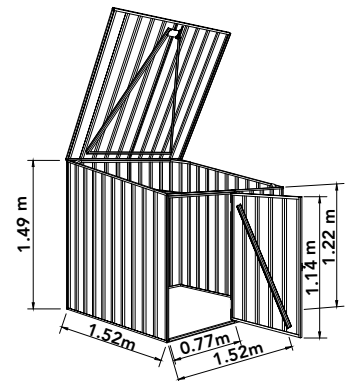

BIKE SHED 230813BK

- » 2.26mW x 0.78mD x 1.31mH
- » Shown in Woodland Grey®
- » Not available in Zincalume®
- » Hatch Skillion Roof, Double Doors
- » Stores up to 3 adult bikes

20' FCL: 156

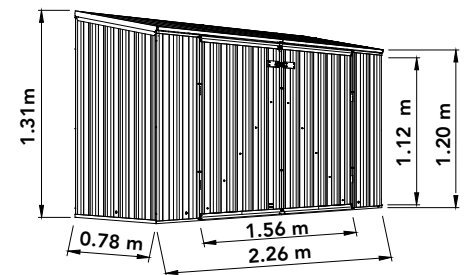

BIKE SHED 30153BK

- » 3.00mW x 1.52mD x 2.08mH
- » Shown in Woodland Grey®
- » Only available in Pale Eucalypt® and Woodland Grey® and Classic Cream™
- » Skillion Roof, Three Doors
- » Wind Rated N2

20' FCL: 156

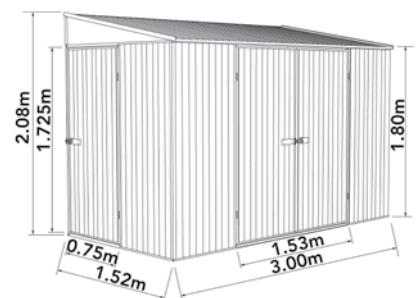

COLOUR OPTIONS:

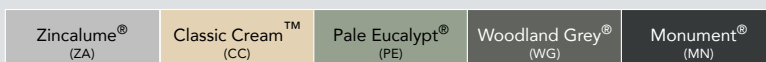

EZI STORAGE



MAINTENANCE
FREE



PRE DRILLED
HOLES



SNAPTITE
SYSTEM



30082EK Shown in Classic Cream™

The Ezi Storage range is designed to give you easy access to your belongings in tight spaces.

PRODUCT

SPECIFICATIONS

DIMENSIONS



EZI STORAGE 08081FK

- » 0.78mW x 0.78mD x 1.80mH
- » Shown in Classic Cream™
- » Flat Roof, Single Door

20' FCL: 156

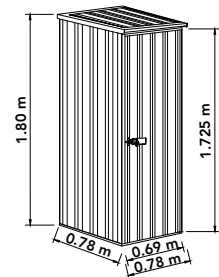

EZI STORAGE 08151FK

- » 0.78mW x 1.52mD x 1.80mH
- » Shown in Monument®
- » Flat Roof, Single Door

20' FCL: 156

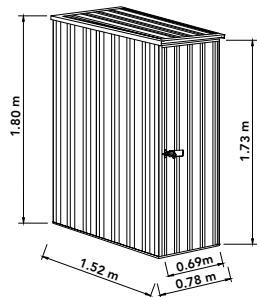

EZI STORAGE 30082EK*

- » 3.00mW x 0.78mD x 1.95mH
- » Shown in Zinalume®
- » Skillion Roof, Double Sliding Doors
- » Wind Rated N2

20' FCL: 156

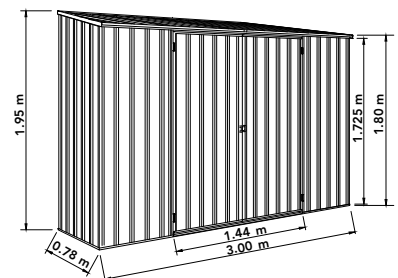

*Wall footprint is 0.78m. The doors/door track sits in front of the walls, making the total depth 0.852m

COLOUR OPTIONS:

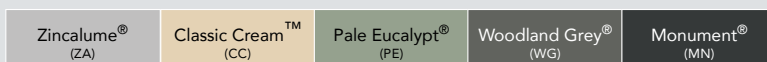

*30082EK only available in Zinalume®, Classic Cream™ and Woodland Grey®

HIGHLANDER SHED



EXTRA
TALL

PRODUCT

SPECIFICATIONS

DIMENSIONS



MODEL 30292HK

- » 3.00mW x 2.92mD x 2.30mH
- » Shown in Zinalume®
- » Gable Roof, Double Doors

20' FCL: 72

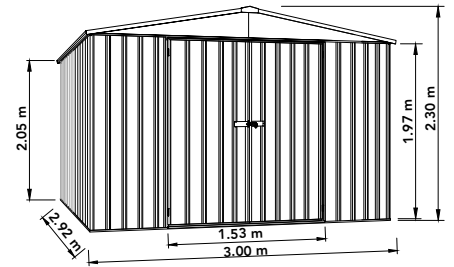

MODEL 45232HK

- » 4.48mW x 2.26mD x 2.30mH
- » Shown in Classic Cream™
- » Gable Roof, Double Doors

20' FCL: 72

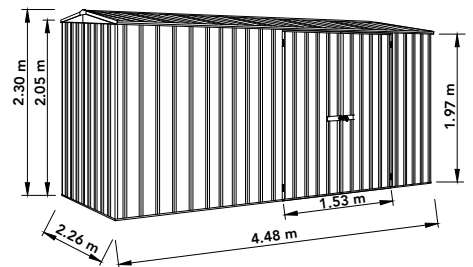

MODEL 60303HK

- » 5.96mW x 3.00mD x 2.30mH
- » Shown in Classic Cream™
- » Gable Roof, Double Doors
- » Single personal access door

20' FCL: 72

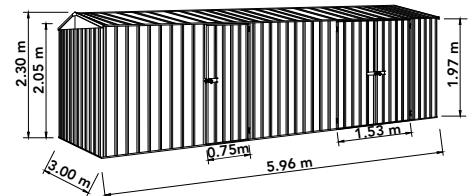

MODEL 3045HK

- » 3.00mW x 4.48mD x 2.30mH
- » Shown in Pale Eucalypt®
- » Gable Roof, Double Doors
- » Single personal access door

20' FCL: 72

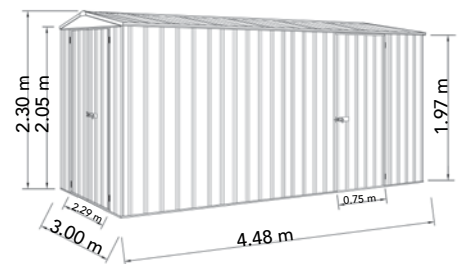

MODEL 3060HK

- » 3.00mW x 5.96mD x 2.30mH
- » Shown in Woodland Grey®
- » Gable Roof, Double Doors
- » Single personal access door

20' FCL: 72

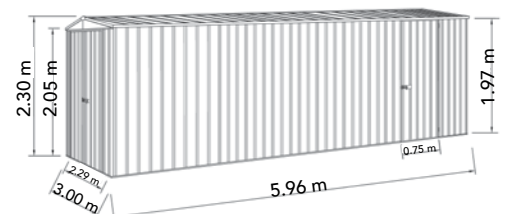

HIGHLANDER COLOUR OPTIONS:

Zinalume®
(ZA)

Classic Cream™
(CC)

Pale Eucalypt®
(PE)

Woodland Grey®
(WG)

EXTRA HIGH GARDEN SHED

2300mm high at the gable, this shed is ideal for the taller person!



Highlander Sheds are wind rated N2. CYCHK Cyclone kit available for these models.

UTILITY SHED



WIND RATED



LIFETIME WARRANTY



ROLLED SAFETY EDGES



3060UTK Shown in Woodland Grey®

Designed for your trailer, boat or car. Featuring an extra large door opening at the gable end, with a personal access side door, braced for added strength and security.

PRODUCT

SPECIFICATIONS

DIMENSIONS



MODEL 3045UTK

- » 3.00mW x 4.48mD x 2.06mH
- » Shown in Zinalume®
- » Gable Roof, Double Door
- » Personal access door included

20' FCL: 72

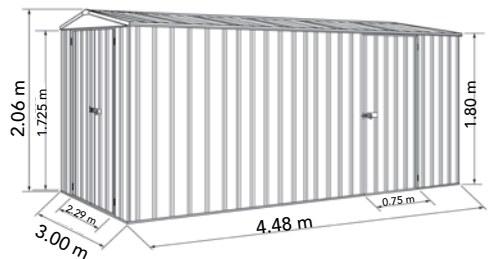

MODEL 3060UTK

- » 3.00mW x 5.96mD x 2.06mH
- » Shown in Pale Eucalypt®
- » Gable Roof, Double Door
- » Personal access door included

20' FCL: 72

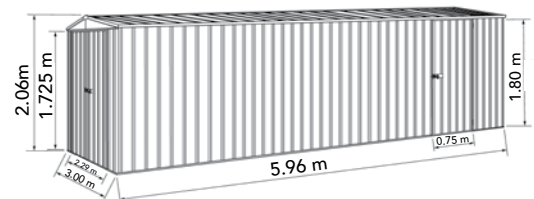

UTILITY COLOUR OPTIONS:

Zinalume®
(ZA)

Classic Cream™
(CC)

Pale Eucalypt®
(PE)

Woodland Grey®
(WG)



Utility Sheds are wind rated N2. CYCWKUTK Cyclone kit available for Workshop and Utility models.

WORKSHOP SHED



60303WK Shown in Zinalume®

Suitable as a workshop for the hobbyist or a large storage area for the serious gardener.

PRODUCT

SPECIFICATIONS

DIMENSIONS



MODEL 45232WK

- » 4.48mW x 2.26mD x 2.00mH
- » Shown in Zinalume®
- » Gable Roof, Double Door

20' FCL: 72

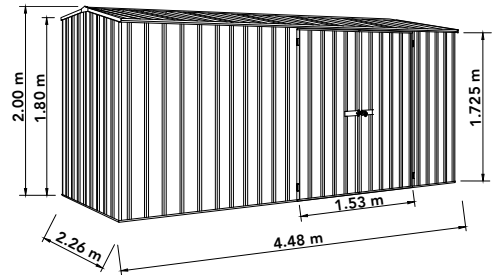

MODEL 45302WK

- » 4.48mW x 3.00mD x 2.06mH
- » Shown in Woodland Grey®
- » Gable Roof, Double Door

20' FCL: 72

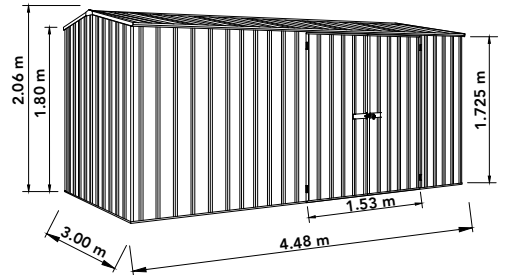

MODEL 60303WK

- » 5.96mW x 3.00mD x 2.06mH
- » Shown in Classic Cream™
- » Gable Roof, Double Door
- » Single personal access door

20' FCL: 72

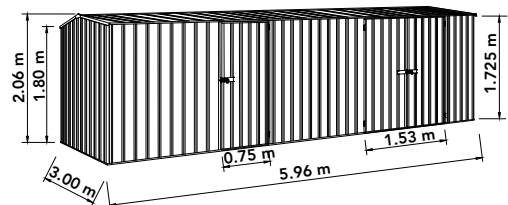

WORKSHOP COLOUR OPTIONS:

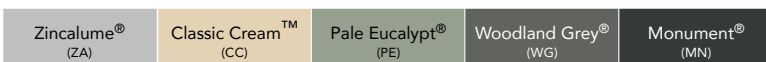

Workshop Sheds are wind rated N2. CYCWKUTK Cyclone kit available for Workshop and Utility models.

FORTRESS SHED

AVAILABLE IN:

Classic Cream™
(CC)

Woodland Grey®
(WG)

Monument®
(MN)

Taking security to the next level.

Heavy duty framework makes the Fortress highly resistant to break-ins.



Model 30151LK Shown in Monument®

PRODUCT

SPECIFICATIONS

DIMENSIONS



MODEL: 30081LK

- » 3.00mW x 0.78mD x 2.40mH
- » Shown in Monument®
- » Roller Door, Flat Roof
- » Downpipes and gutters included
- » Strong internal bracing

20' FCL: 156

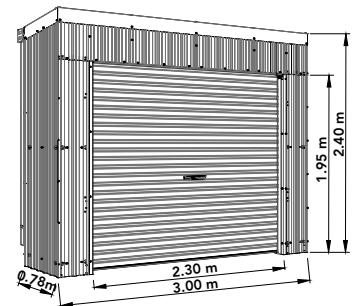

*Wall footprint is 0.78m. The gutter/downpipe sits behind the shed making the total depth 0.90m



MODEL: 30151LK

- » 3.00mW x 1.52mD x 2.40mH
- » Shown in Classic Cream™
- » Roller Door, Flat Roof
- » Downpipes and gutters included
- » Strong internal bracing

20' FCL: 156

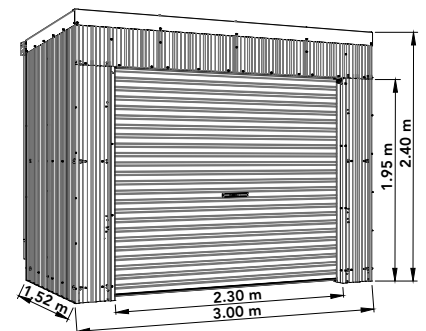

MODEL: 30301LK

- » 3.00mW x 3.00mD x 2.40mH
- » Shown in Woodland Grey®
- » Roller Door, Flat Roof
- » Downpipes and gutters included
- » Strong internal bracing

20' FCL: 156

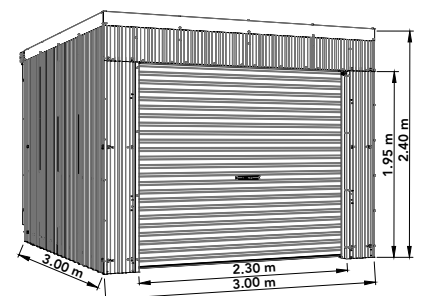

BUSHRANGER SHED



ROLLER
DOOR



STRONG
INTERNAL
BRACING



7 DAY
SUPPORT



3023BRK Shown in Woodland Grey®

The perfect combination of both a garden shed and garage, designed to have extra strong internal bracing, the Bushranger Shed is stronger than just your average garden shed.

PRODUCT

SPECIFICATIONS

DIMENSIONS



BUSHRANGER 3023BRK

- » 3.00mW x 2.26mD x 2.30mH
- » Shown in Classic Cream™
- » Matching Roller Shutter Door
- » Gable roof

20' FCL: 72

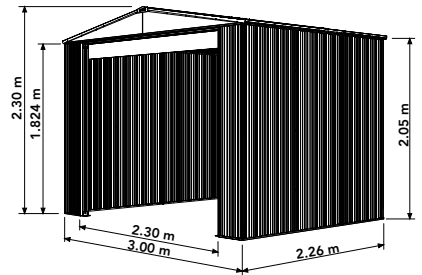

BUSHRANGER 3030BRK

- » 3.00mW x 3.00mD x 2.30mH
- » Shown in Pale Eucalypt® with Surf Mist® door
- » Gable roof
- » Door in Surf Mist®

20' FCL: 72

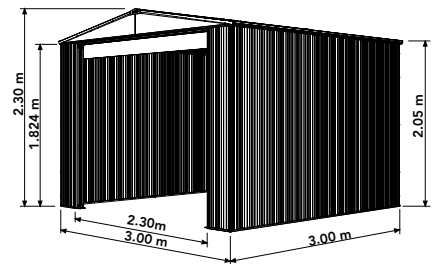

HIGHLANDER GARAGE 3060HGK

- » 3.00mW x 5.96mD x 2.30mH
- » Shown in Woodland Grey®
- » Matching Door
- » Single side access door included

20' FCL: 72

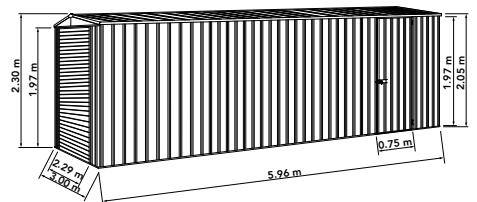

COLOUR OPTIONS:

Classic Cream™
(CC)

Pale Eucalypt®
(PE)

Woodland Grey®
(WG)

NOTE: All models come with a SurfMist® gable piece. Pale Eucalypt Bushrangers have a SurfMist® Door, all other models have a matching door. All Bushrangers come with a Rollashield Premium Roller Shutter Door, with an optional electric motor (sold separately at time of purchase). The warranty of both the Rollashield Premium Roller Shutter Door and electric motor are not covered under Absco's Lifetime Warranty.

Zincalume®
(ZA)

Pale Eucalypt®
(PE)

PRODUCT

SPECIFICATIONS

DIMENSIONS



MODEL: A15081FKFD

- » 1.52mW x 0.78mD x 1.80mH
- » Shown in Pale Eucalypt®
- » Wide mesh panels for easy viewing
- » Flat Roof, Single Door

20' FCL: 156



MODEL: A15151FKFD

- » 1.52mW x 1.52mD x 1.80mH
- » Shown in Zincalume®
- » Wide mesh panels for easy viewing
- » Flat Roof, Single Door

20' FCL: 156

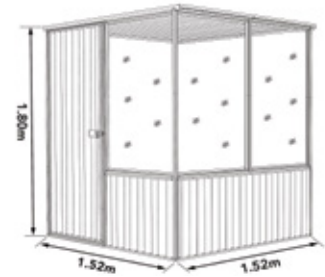

MODEL: A15301FKFD

- » 1.52mW x 2.96mD x 1.80mH
- » Shown in Pale Eucalypt®
- » Wide mesh panels for easy viewing
- » Flat Roof, Single Door

20' FCL: 156

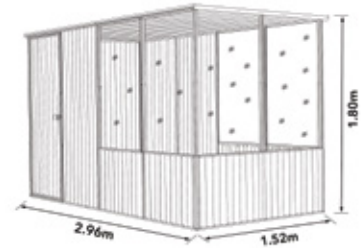

MODEL: A23151GKFD

- » 2.26mW x 1.52mD x 2.00mH
- » Shown in Zincalume®
- » Wide mesh panels for easy viewing
- » Gable Roof, Single Door

20' FCL: 156

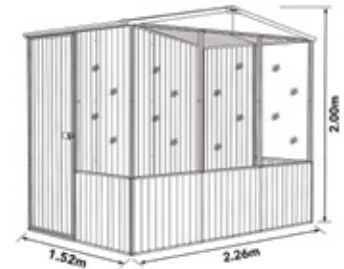

MODEL: A23231GKFD

- » 2.26mW x 2.22mD x 2.00mH
- » Shown in Pale Eucalypt®
- » Wide mesh panels for easy viewing
- » Gable Roof, Single Door

20' FCL: 156

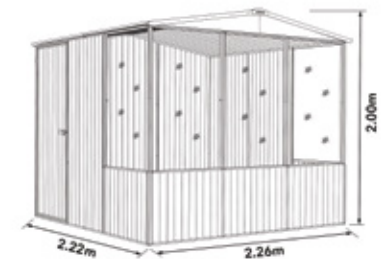

MODEL: A30231GKFD

- » 3.00mW x 2.22mD x 2.06mH
- » Shown in Zincalume®
- » Wide mesh panels for easy viewing
- » Gable Roof, Single Door

20' FCL: 156



ACCESSORIES



ANCHOR KITS

- » 4 Pack includes:
 - » 4 x 10mm Bolts & Nuts
 - » 4 x Strong 3mm Galvanised Brackets
 - » 4 x 10mm Dynabolts
- » Model: ANCHOR4
- » Permanent secure installation
- » Manufacturers 10 Year Warranty
- » Warranty Compliant for Absco Sheds

8 ANCHORS (2 packs)	12 ANCHORS (3 packs)	16 ANCHORS (4 packs)	24 ANCHORS (6 packs)
1.52m x 0.78m	2.26m x 1.52m	3.00m x 1.52m	3.00m x 4.48m
1.52m x 1.52m	2.26m x 2.26m	3.00m x 2.26m	3.00m x 5.22m
2.26m x 0.78m		3.00m x 3.00m	4.48m x 2.26m
3.00m x 0.78m		3.00m x 3.70m	4.48m x 3.00m
			5.22m x 2.26m
			6.00m x 3.00m

SNOW FRAMES

- » Model: SNOW3018
- » Ensures strength during winter
- » Fits inside 3m wide garden sheds
- » Number of snow frames required depends on size of the shed.
Please refer to our website:
www.absco sheds.com.au



Most Absco Sheds are approved to Australian Standards AS11790.2.02 non-cyclonic conditions (N2)*. Installing a Cyclone Kit will upgrade your shed to C1. Please check the wind rating carefully and check the requirements with your local council before purchasing.

Information

- » Each frame kit is compatible with multiple shed sizes, as our sheds range in size from 1.5m to 6m. Cutting the frame to size is necessary for some models.
- » Installation of the Cyclone Kit is required *during* the garden shed assembly for the Regent, Utility, Workshop and Highlander Cyclone Kits. The Space Saver, Premier and 1.5m Cyclone Kits can be installed after shed construction.

CYCLONE/HURRICANE KITS

MODEL	CYCLONE KIT
1.5mW x 1.5mD Sheds	CYC15
Space Saver Range	CYCKRSK
Premier Range	CYCGK
Regent Range	CYCRK
Utility Range	CYCWKUTK
Workshop Range	
Highlander Range	CYCHK



“We have a block of land in Mission Beach with an Absco Shed on it. Our shed has survived both Cyclone Larry and Cyclone Yasi and we couldn't be happier or more relieved to find it still intact thanks to the Absco Cyclone Kit installed.”

PATRICK, MISSION BEACH QLD
CUSTOMER TESTIMONIAL

Absco Sheds have undertaken every effort to ensure all images, pricing and product information is correct and relevant at the time of printing. We reserve the right to correct printing errors at any time without notice. Images included in this catalogue are for illustrative purposes only and may not show all or correct colours, product features and/or optional extras. Absco Sheds - March 2022

ABSCO SHEDS MATRIX TABLE

DIMENSIONS
& WIND RATINGS

CODE	SHED SIZE				CLEARANCES		WIND RATING	CYCLONE KIT UPGRADE
	WIDTH (mW)	DEPTH (mD)	WALL HEIGHT (mH)	HIGHEST POINT (mH)	DOOR			
					WIDTH (mm)	HEIGHT (mm)	N2	C1
SPACE SAVER								
15081SK	1.52	0.78	1.80	1.95	750	1725	X	
15151SK	1.52	1.52	1.80	2.08	750	1725	X	CYC15
23081SK	2.26	0.78	1.80	1.95	750	1725		
23151SK	2.26	1.52	1.80	2.08	750	1725	X	CYCSKRSK
30082SK	3.00	0.78	1.80	1.95	1530	1725		
30151SK	3.00	1.52	1.80	2.08	750	1725	X	CYCSKRSK
30152SK	3.00	1.52	1.80	2.08	1530	1725	X	CYCSKRSK
REVERSE SKILLION SPACE SAVER								
15081RSK	1.52	0.78	1.65	1.80	750	1725	X	
23151RSK	2.26	1.52	1.52	1.80	750	1725	X	CYCSKRSK
PREMIER								
15151GK	1.52	1.52	1.80	1.95	750	1725	X	CYC15
23151GK	2.26	1.52	1.80	1.95	750	1725	X	CYCGK
23231GK	2.26	2.26	1.80	2.00	750	1725	X	CYCGK
30152GK	3.00	1.52	1.80	1.95	1530	1725	X	CYCGK
30232GK	3.00	2.26	1.80	2.00	1530	1725	X	CYCGK
30302GK	3.00	3.00	1.80	2.06	1530	1725	X	CYCGK
REGENT								
23141RK	2.26	1.44	1.80	2.00	750	1725	X	CYCRK
23221RK	2.26	2.18	1.80	2.00	750	1725	X	CYCRK
30142RK	3.00	1.44	1.80	2.06	1530	1725	X	CYCRK
30222RK	3.00	2.18	1.80	2.06	1530	1725	X	CYCRK
30292RK	3.00	2.92	1.80	2.06	1530	1725	X	CYCRK
30372RK	3.00	3.66	1.80	2.06	1530	1725	X	CYCRK
BASIC SHEDS								
15231FK	1.52	2.26	1.80	1.80	750	1725	X	
15301FK	1.52	3.00	1.80	1.80	750	1725	X	
BIKE SHED								
230813BK	2.26	0.78	1.31	1.31	1560	1120		
30153BK	3.00	1.52	1.80	2.08	1530	1725	X	
POOL PUMP COVER								
PPCK	1.52	1.52	1.22	1.49	770	1140		
EZI STORAGE RANGE								
08081FK	0.78	0.78	1.80	1.80	690	1725		
08151FK	0.78	1.52	1.80	1.80	690	1725		
30082EK	3.00	0.78	1.80	1.95	1440	1725	X	
HIGHLANDER								
30292HK	3.00	2.92	2.05	2.30	1530	1970	X	CYCHK
3045HK	3.00	4.48	2.05	2.30	2290	1970	X	CYCHK
3060HK	3.00	5.96	2.05	2.30	2290	1970	X	CYCHK
45232HK	4.48	2.26	2.05	2.30	1530	1970	X	CYCHK
60303HK	5.96	3.00	2.05	2.30	1530	1970	X	CYCHK
UTILITY								
3045UTK	3.00	4.48	1.80	2.06	2290	1725	X	CYCWKUTK
3060UTK	3.00	5.96	1.80	2.06	2290	1725	X	CYCWKUTK
WORKSHOP								
45232WK	4.48	2.26	1.80	2.00	1530	1725	X	CYCWKUTK
45302WK	4.48	3.00	1.80	2.06	1530	1725	X	CYCWKUTK
60303WK	5.96	3.00	1.80	2.06	1530	1725	X	CYCWKUTK
FORTRESS SHED								
30081LK	3.00	0.78	2.4	2.4	2300	1950		
30151LK	3.00	1.52	2.4	2.4	2300	1950		
30301LK	3.00	3.00	2.4	2.4	2300	1950		
BUSHRANGER SHEDS								
3023BRK	3.00	2.26	2.05	2.30	2300	1824		
3030BRK	3.00	3.00	2.05	2.30	2300	1824		
3060HGK	3.00	5.96	2.05	2.30	2290	1970		
CHICKEN COOPS								
A15081FKFD	1.52	0.78	1.80	1.80	700	1725		
A15151FKFD	1.52	1.52	1.80	1.80	700	1725		
A15301FKFD	1.52	2.96	1.80	1.80	700	1725		
A23151GKFD	2.26	1.52	1.80	2.00	700	1725		
A23231GKFD	2.26	2.22	1.80	2.00	700	1725		
A30231GKFD	3.00	2.22	1.80	2.06	700	1725		



CONTACT US 7 DAYS A WEEK

 6-12 Activity St, Acacia Ridge QLD 4110
PO Box 119, Acacia Ridge QLD 4110

 AU 1800 029 701
NZ 0800 466 444

 admin@absco.com.au
www.abscohed.com.au